

Winter Komoda

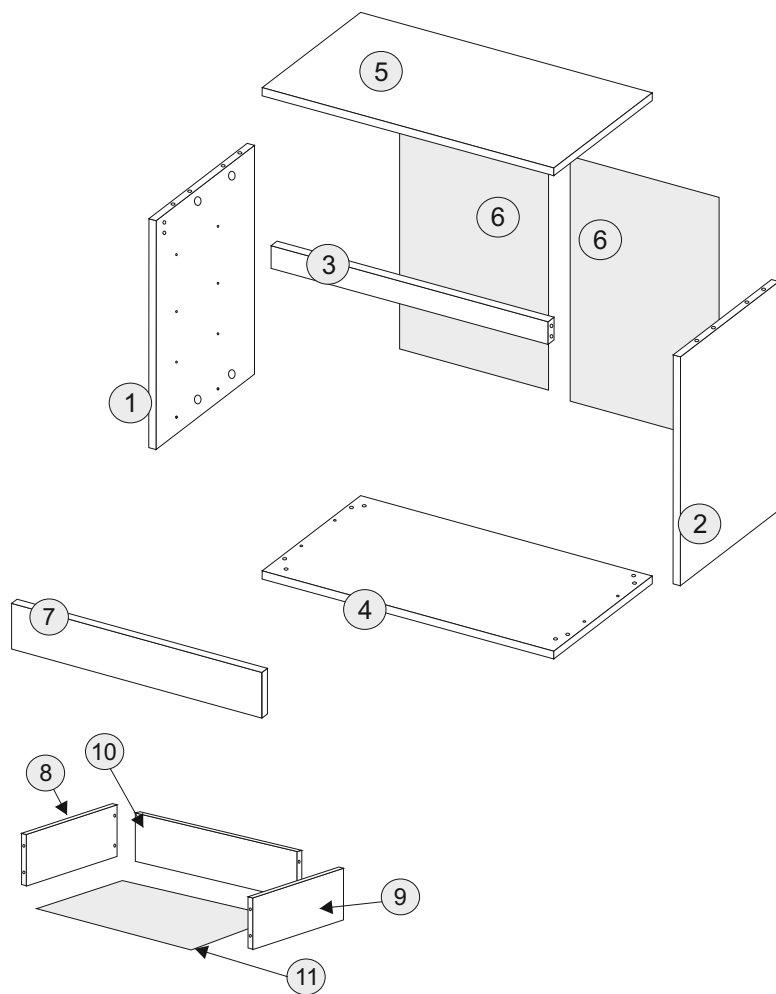

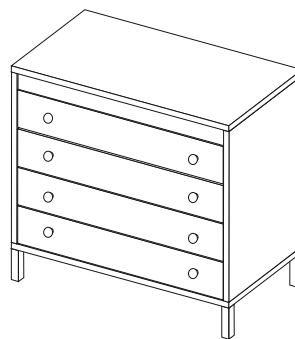

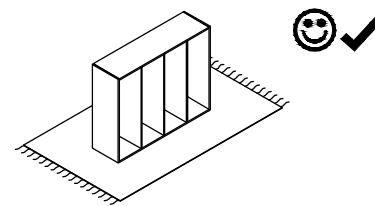

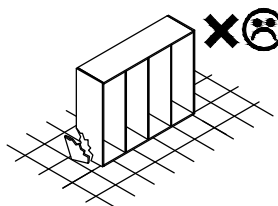
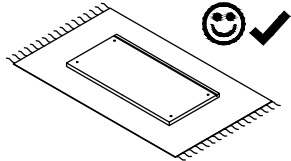
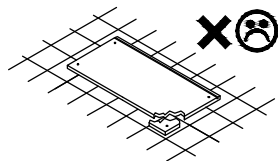
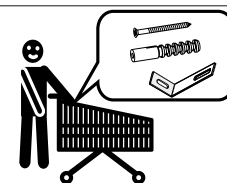
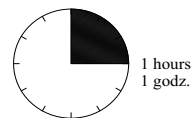
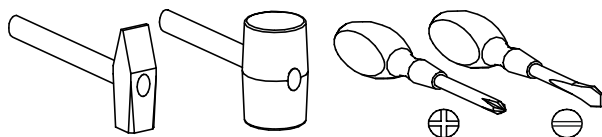

- PL **Instrukcja montażu**
- D **Aufbauanleitung**
- GB **Assembly instruction**
- NL **Handleiding**

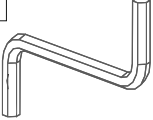

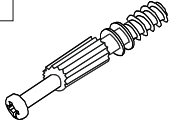
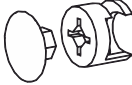
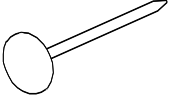
1	915x400	1
2	915x400	1
3	768x80	1
4	802x400	1
5	802x400	1
6	941x398	2
7	762x205	4
8	350x150	4
9	350x150	4
10	710x150	4
11	740x355	4

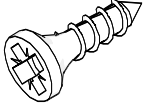
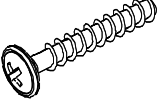

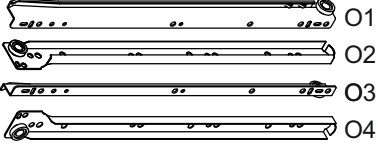
Akcesoria - Accessories - die Accessoires

A  x1	B  x36	C  x8	D  x8	M.  x35
J  x1	F 3.5x13  x16	G 4x30  x8	H  x8	L  x12
O  O1 O2 O3 O4		S  x4		N 5.3x13 euro  x16

