

Kledingkast Miami

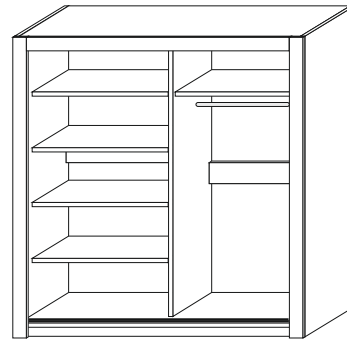

(PL)

Instrukcja montażu

(D)

Aufbauanleitung

(GB)

Assembly instruction

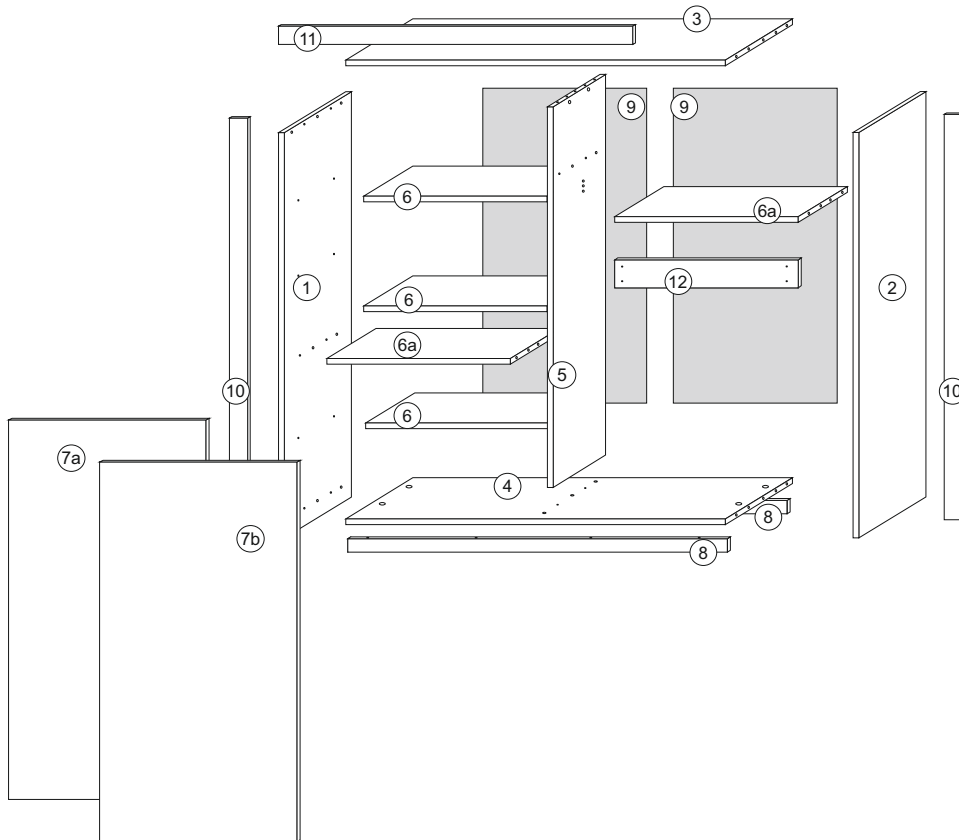

(NL)

Handleiding

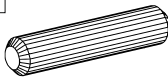
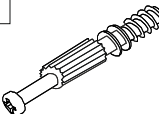
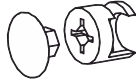
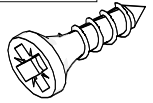
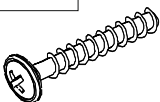
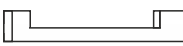
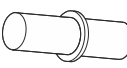

lp	Wymiar	ilość
1	1990x620	1
2	1990x620	1
3	1168x620	1
4	1168x620	1
5	1877x500	1
6	576x500	5
7a	657x800	1
7b	657x800	1
8	1168x80	2
9	1910x599	2
10	1990x80	2
11	1143x80	1
12	576x125	2

Akcesoria - Accessories - die Accessoires

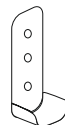
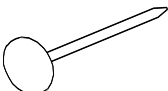
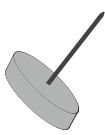
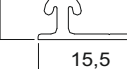
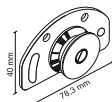
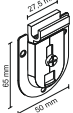
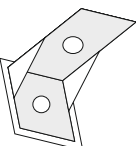
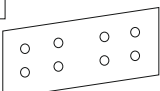
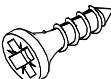
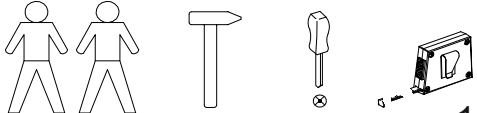
S		x8	B		x34	C		x20	D		x20	F 3.5x16		x60
G 4x25		x4	H		x2	I		x12	J		x1	K		x2
M.		x100	P.		x8	U		x4	U1		x4	U2		x4
V		x22	W		x2	Y 3x16		x16						

I

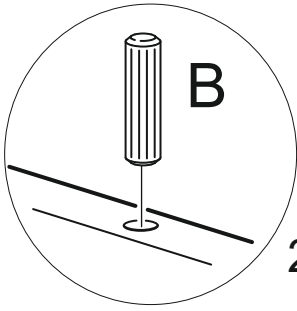

26x

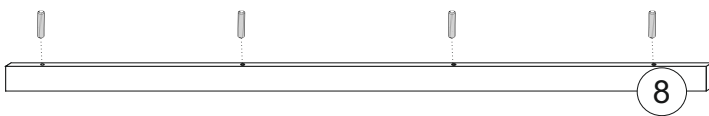
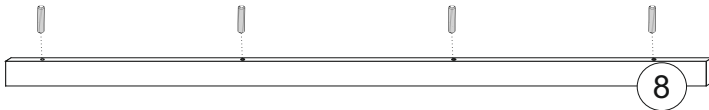
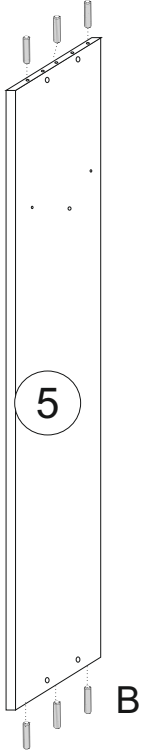
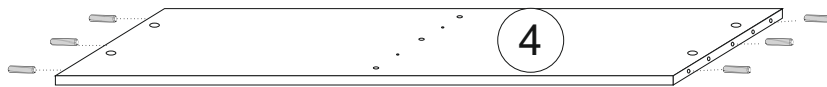
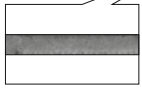
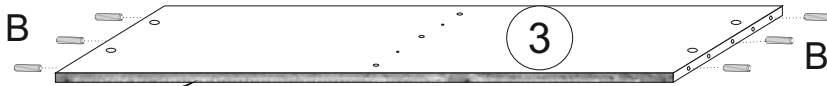
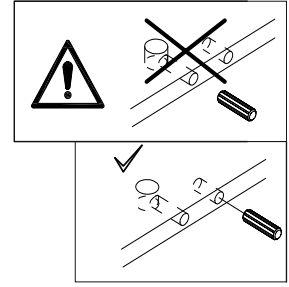
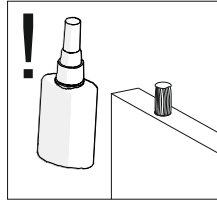

II

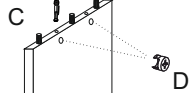
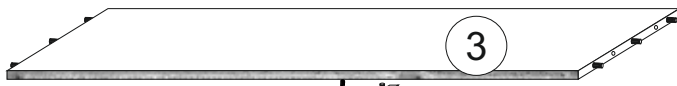

5

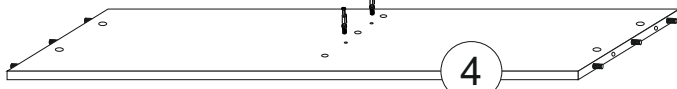
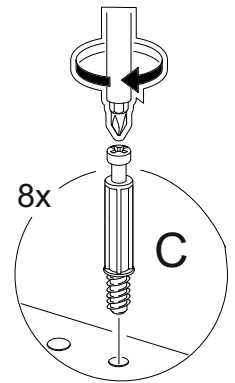
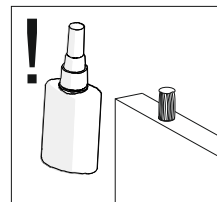

4

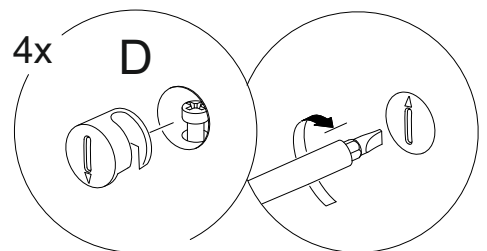

III

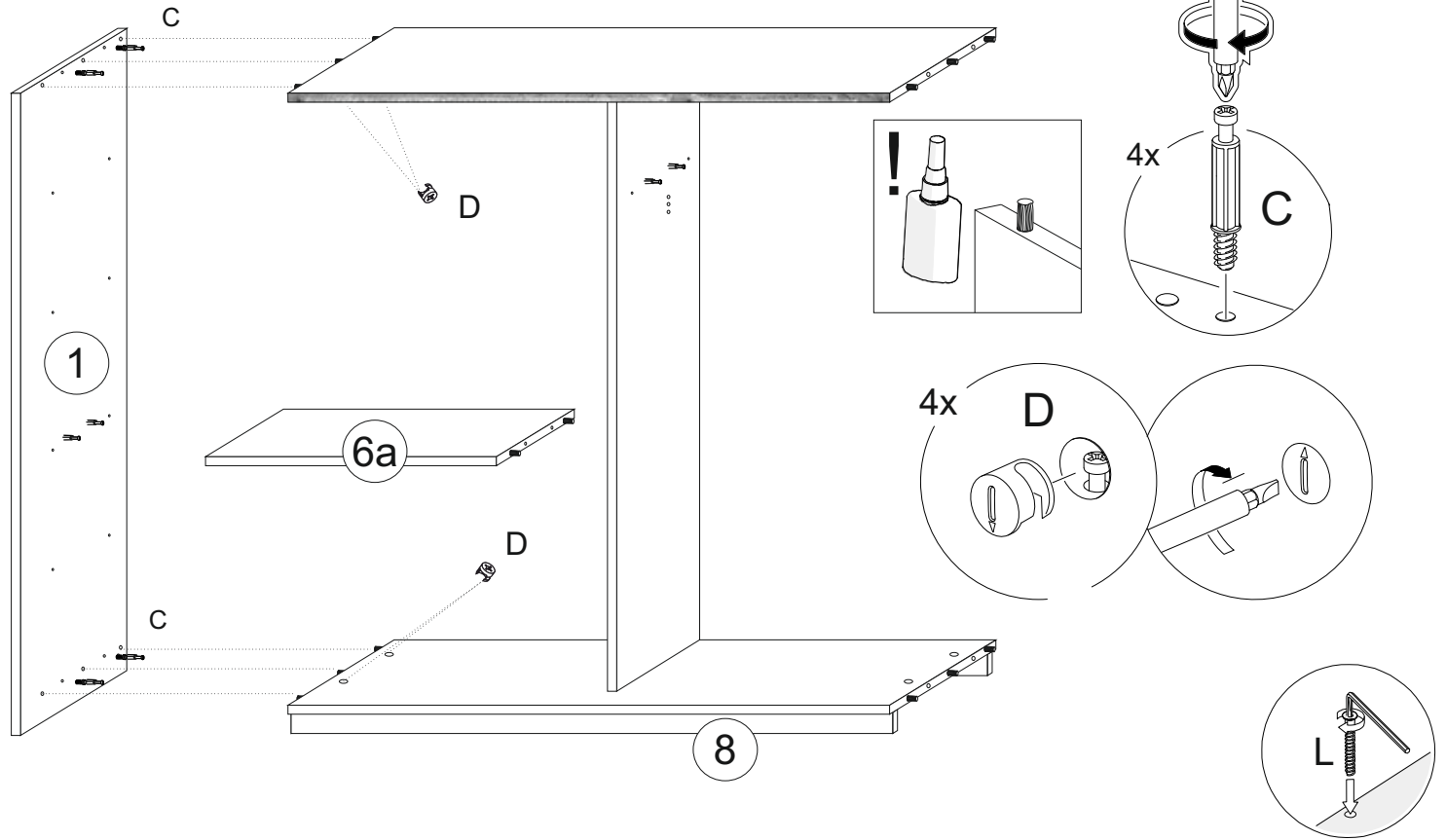

IV

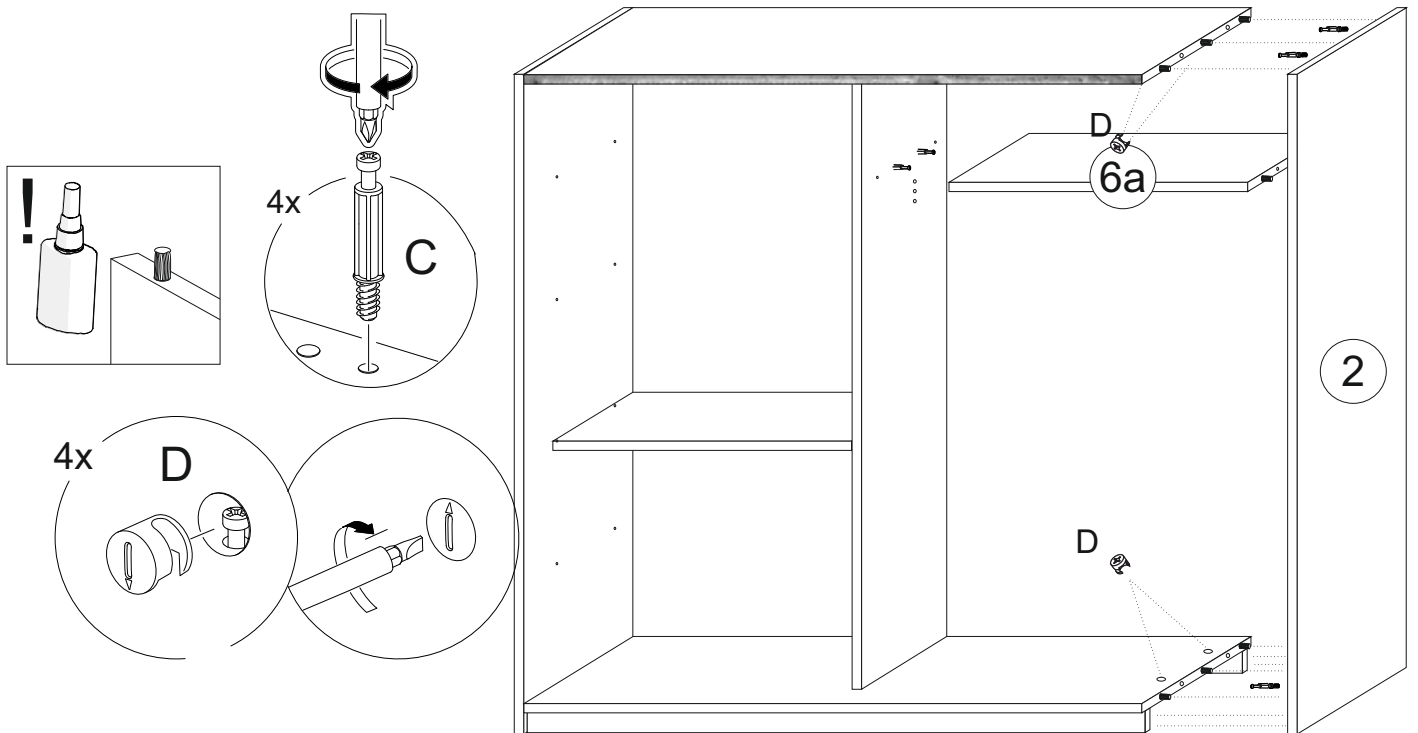

V

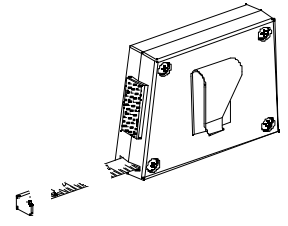
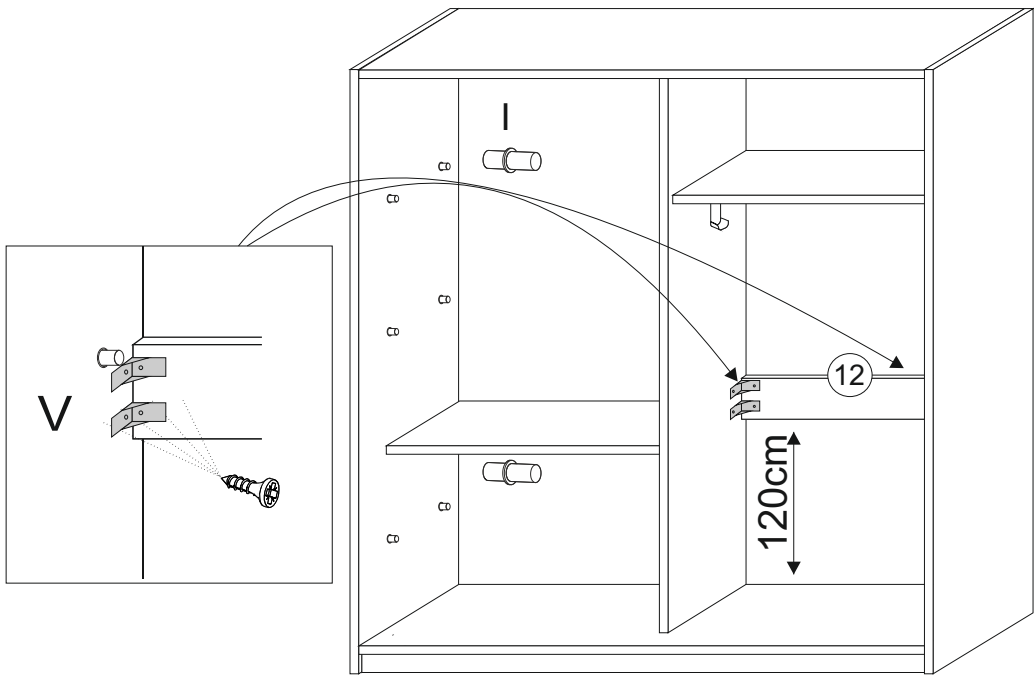

VI

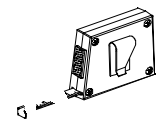
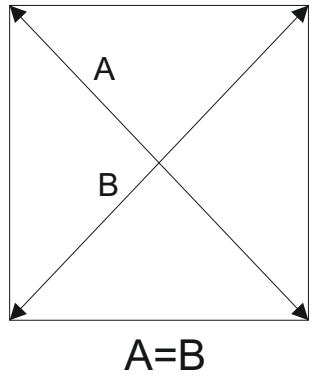
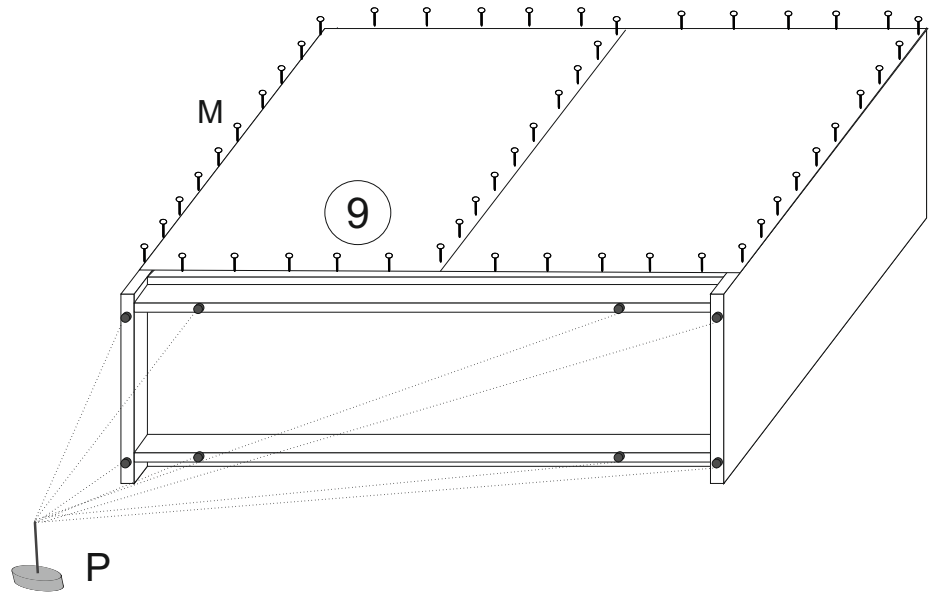

VII

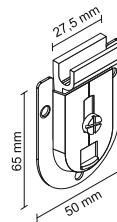
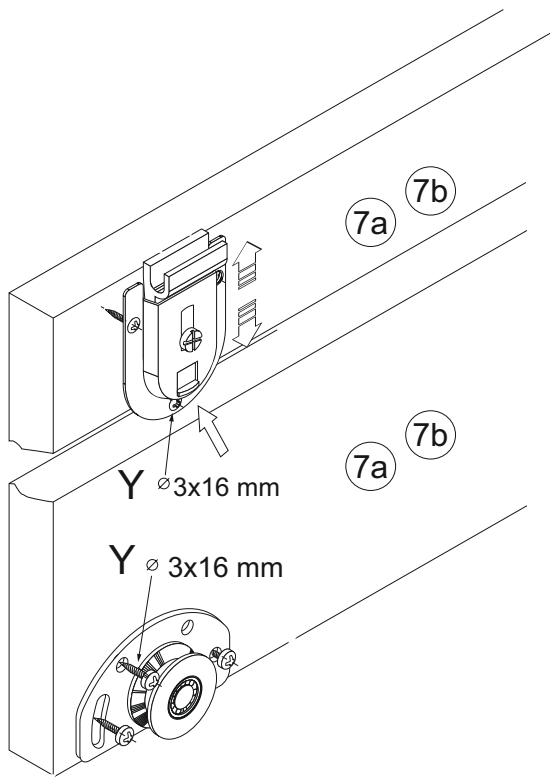

U2

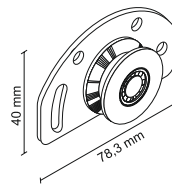

U1

VIII

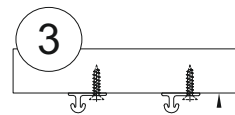
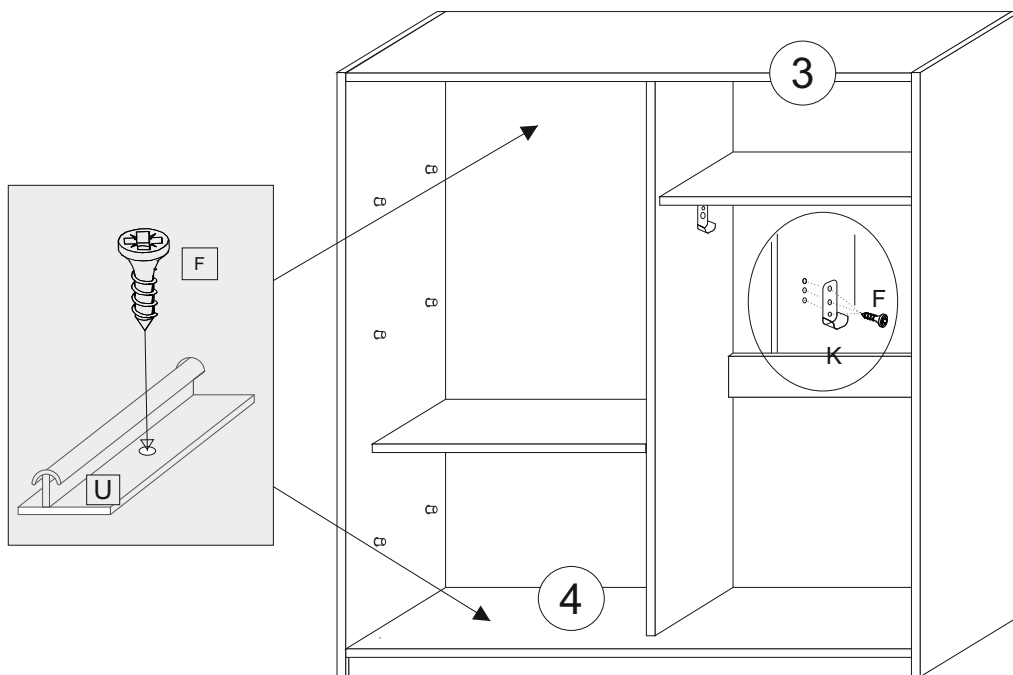

FRONT

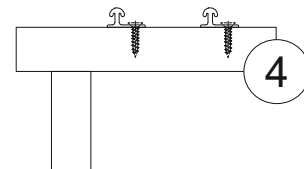

IX

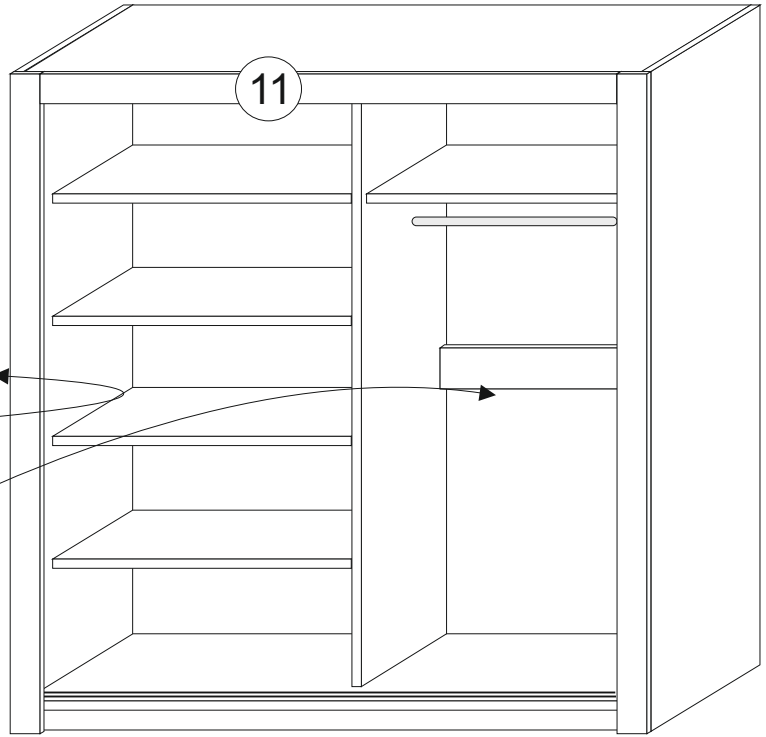
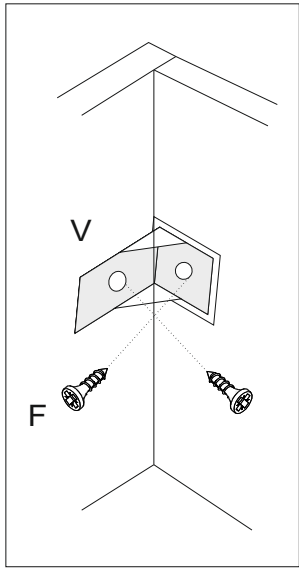
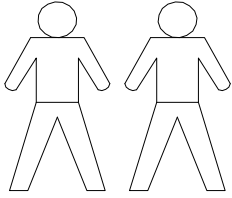

X

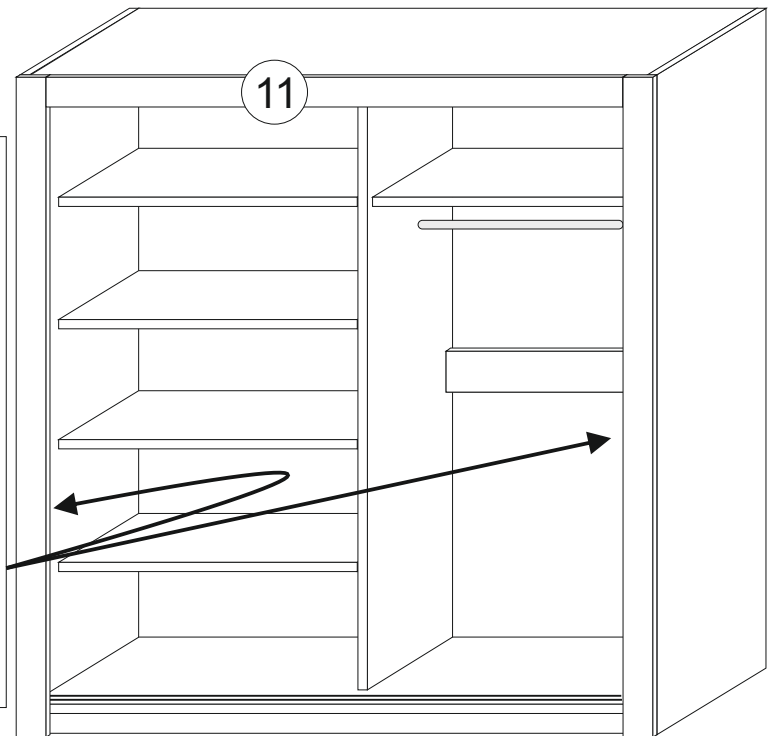
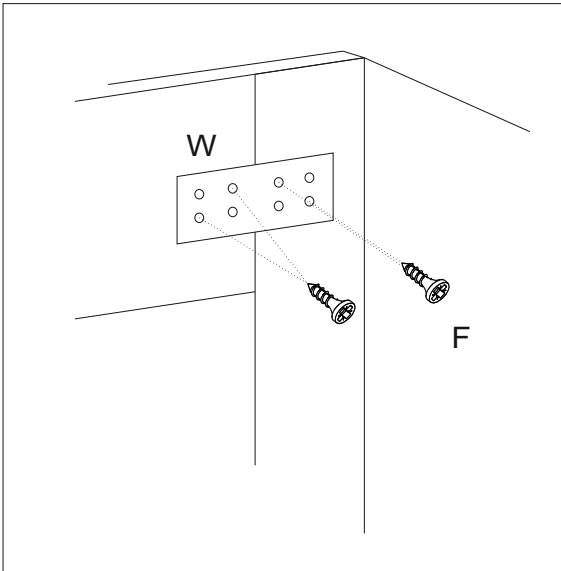

XI

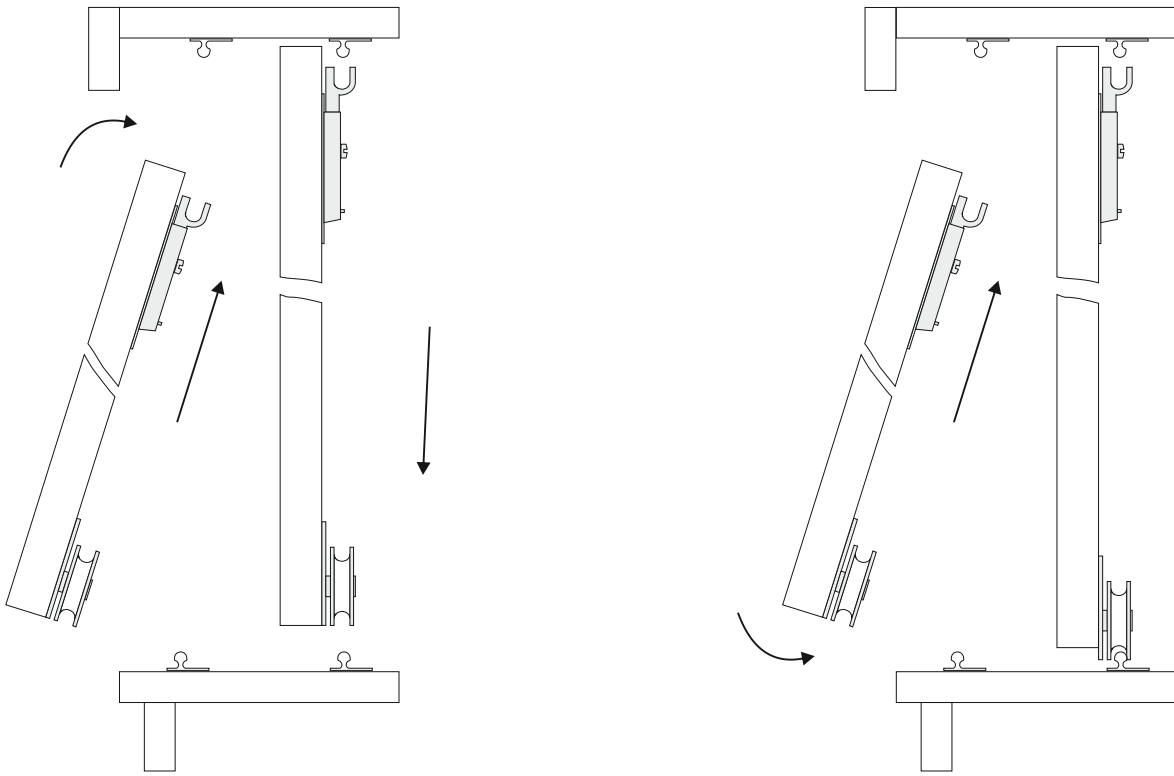

Door Adjusting follow steps below

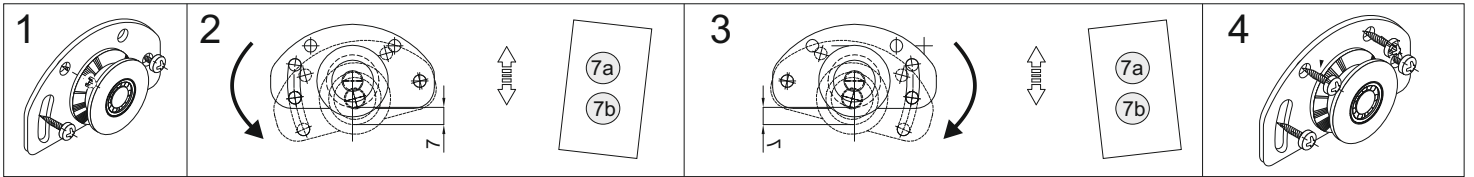

1.

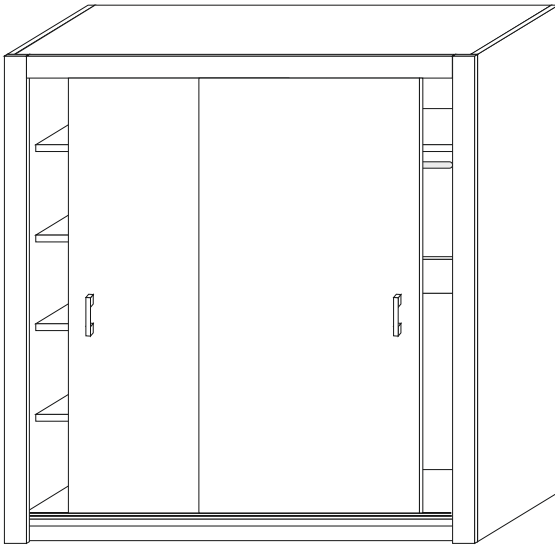
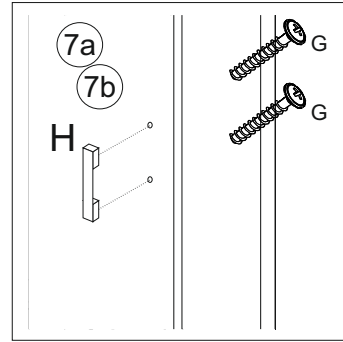
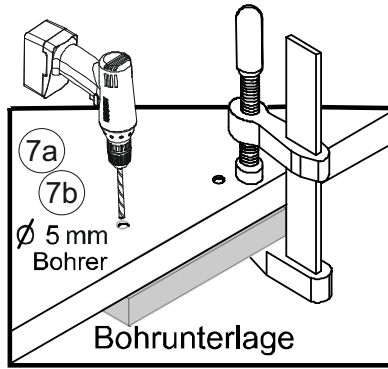

- Ⓓ Das Möbel muss an der Wand befestigt werden!
- Ⓒ🇸 Please ensure to mount the furniture to the wall!
- Ⓕ Les meubles doivent être fixés au mur!
- Ⓖ Het meubel moet aan de wand worden vastgemaakt!
- Ⓔ El mueble se tiene que fijar a la pared!
- Ⓗ Mebel należy przymocować do ściany!



- Ⓓ Informieren Sie sich vor der Wandmontage über das geeignete Montagematerial!
- Ⓒ🇸 Please get informed on suitable assembly materials before commencing the wall-mounting!
- Ⓕ Renseignez-vous sur le matériel de montage approprié avant le montage mural!
- Ⓖ Informeer u voor de wandmontage over het geschikte montagematerieel!
- Ⓔ Infórmese antes del montaje en la pared del material apropiado de montaje!
- Ⓗ Przed montażem na ścianie upewnij się, jaki jest potrzebny właściwy materiał montażowy!



- Ⓓ Beschaffen Sie sich das angemessene Material zur Wandbefestigung!
- Ⓒ🇸 Please obtain suitable wall-mounting materials!
- Ⓕ Procurez-vous le matériel approprié pour le montage mural!
- Ⓖ Verschaf u het adequate materieel voor de wandbevestiging!
- Ⓔ Procúrese el material adecuado para la fijación a la pared!
- Ⓗ Zakup odpowiedni materiał do przymocowania na ścianie!

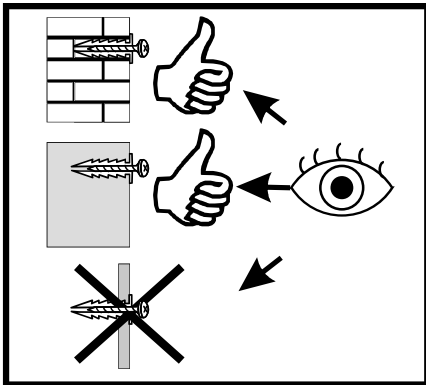

- Ⓓ Lassen Sie die Wandbefestigung von einer fachkundigen Person vornehmen!
- Ⓒ🇸 Ensure all wall-mounting is carried out by competent personnel!
- Ⓕ Faites effectuer le montage mural par une personne compétente!
- Ⓖ Laat de wandbevestiging door een professional uitvoeren!
- Ⓔ Deje que la fijación a la pared la haga un profesional!
- Ⓗ Zleć przymocowanie do ściany odpowiednio doświadczonej osobie!

